



Equipment for the Foodservice Industry
value + quality + service

X-LINE 27" Worktop Freezer with Backsplash

Model No:
FWDR1-27VCX-R



FWDR1-27VCX-R Features

Features:

- Exterior & interior stainless steel construction
- Environmentally friendly R290 refrigerant
- Heavy duty Embraco compressor
- Self-closing and stay open door
- Efficient refrigeration system holds -8°F to 1°F (-22°C to -18°C)
- Recessed door handle
- Removable gasket that is easy to clean and replace
- Casters for easy movement
- Pre-installed shelves

Warranty:

- Two year parts and labour; Five years on compressor. *For full warranty details visit <https://www.efifoodequip.com/warranty-info.php>*



FWDR1-27VCX-R Specifications

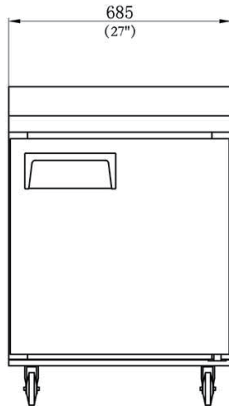

ELEVATION

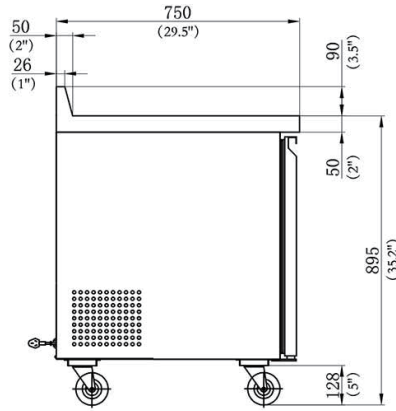

SECTION VIEW

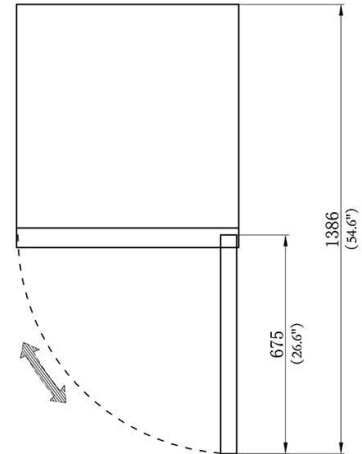

PLAN

Model	Refrigerant	Doors	Shelves	Dimension (mm) (inch)			HP	Voltage	Amps	Capacity (L) (Cu Ft.)	Net Weight (KG) (LBS)	Temperature Range
				W	D	H						
FWDR1-27VCX-R	R290	1	1	685	750	984	1/5	115/60	1.8	202	72	-8 ~ -1°F
				27	29.5	38.7						

Equipped with one NEMA 5-15P plug 

Shipping Information

Crate Dimensions (mm) (inch)			Net Weight (KG) (LBS)	Gross Weight (KG) (LBS)
W	D	H		
755	820	1070	72	92
29.7	32.3	42.1	158.7	202.8

Specifications subject to change without notice.