



Equipment for the Foodservice Industry
value + quality + service

X-LINE 36" Worktop Refrigeration with Backsplash

Model No:
CWDR2-36VCX



CWDR2-36VCX Features

Features:

- Exterior & interior stainless steel construction
- Environmentally friendly R290 refrigerant
- Heavy duty Embraco compressor
- Self-closing and stay open door
- Efficient refrigeration system holds 33°F to 45°F (0.5°C to 8°C)
- Recessed door handle
- Removable gasket that is easy to clean and replace
- Casters for easy movement
- Pre-installed shelves

Warranty:

- Two year parts and labour; Five years on compressor. *For full warranty details visit <https://www.efifoodequip.com/warranty-info.php>*



CWDR2-36VCX Specifications

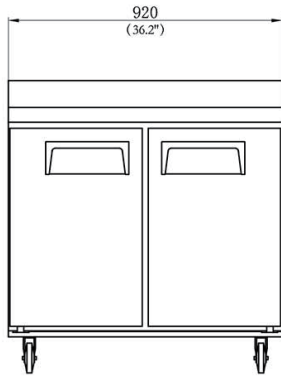

ELEVATION

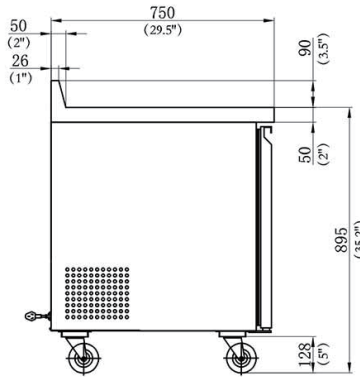

SECTION VIEW

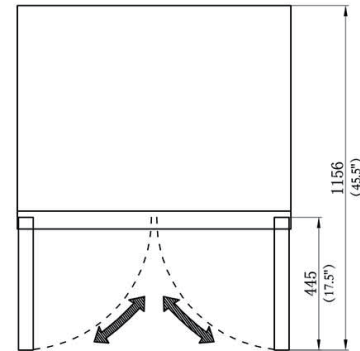

PLAN

Model	Refrigerant	Doors	Shelves	Dimension (mm) (inch)			HP	Voltage	Amps	Capacity (L) (Cu Ft.)	Net Weight (KG) (LBS)	Temperature Range
				W	D	H						
CWDR2-36VCX	R290	2	2	920	750	984	1/6	115/60	2.3	269	90	0.5 ~ 8°C
				36.2	29.5	38.7				9.5	198.4	33 ~ 45°F

Equipped with one NEMA 5-15P plug 

Shipping Information

Crate Dimensions (mm) (inch)			Net Weight (KG) (LBS)	Gross Weight (KG) (LBS)
W	D	H		
990	820	1070	90	115
39	32.3	42.1	198.4	253.3

Specifications subject to change without notice.